

TRITONE

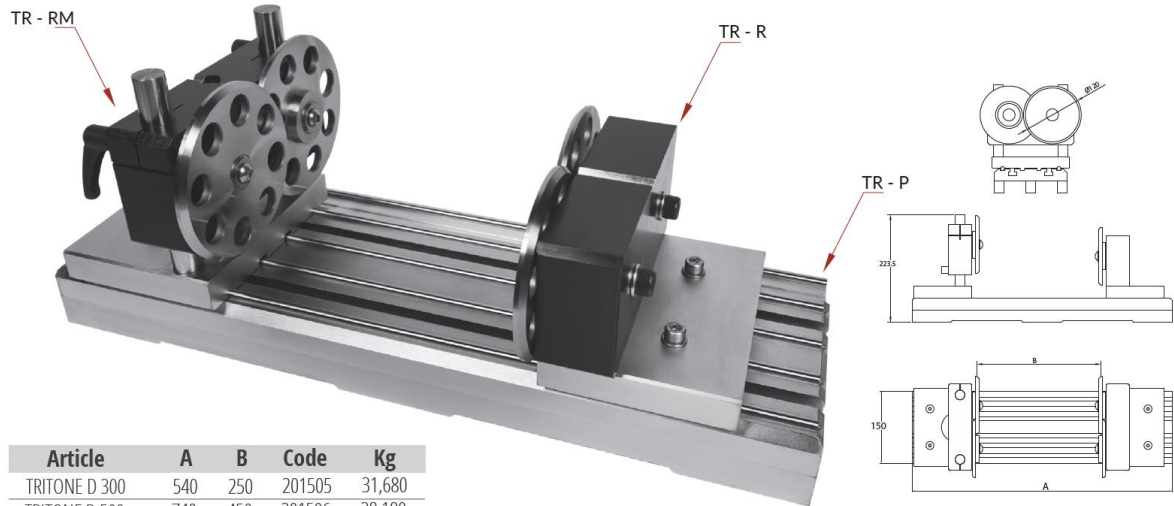

MEASURE INSTRUMENTS STRUMENTI CONTROLLO

- For check linearity, balancing and cylindricity
- Base length 300 or 500 mm. with 2 T-slots 12 mm.
- One rolling block fixed (TR-R) and one adjustable range 50 mm. (TR-RM)
- Concentricity accuracy: 0,0025 mm.
- Per controllo linearità, bilanciatura e cilindricità
- Base da 300 o 500 mm. con 2 cave a T 12 mm.
- Un supporto a dischi fissi (TR-R) ed uno a dischi mobili con altezza regolabile corsa 50 mm. (TR-RM)
- Precisione: 0,0025 mm.



Article	A	B	Code	Kg
TRITONE D 300	540	250	201505	31,680
TRITONE D 500	740	450	201506	38,180

STANDARD AND OPTIONAL SUPPLY BANCOPUN-TRITONE-BANCO SV DOTAZIONE STANDARD E OPTIONAL PER BANCOPUN-TRITONE-BANCO SV

SLAB TR-P PIASTRA TR-P

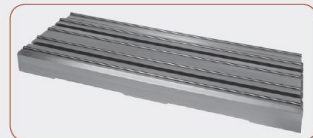

Article	A	Code	Kg
PIASTRA TR P 300	540	201501	17,000
PIASTRA TR P 500	740	201502	23,500

CONTROPUNTE CONTROPUNTE



SUPPORT WITH FIXED DISK SUPPORTO A DISCHI FISSI

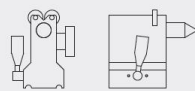

Article	Code	Kg
CP M	201531	2,200

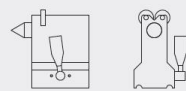

Article	Code	Kg
CP F	201530	2,100

SUPPORT WITH FIXED DISK SUPPORTO A DISCHI FISSI

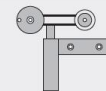

Movable pressor Pressore mobile

Article	Code	Kg
ALT PT	201515	0,500

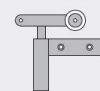

Pressor Pressore

Article	Code	Kg
ALT PF	201516	0,480

PRESSOR PRESSORI

MOVABLE SUPPORTS PORTACOMPARATORI



Movable Support for dial gauge Portacomparatore Mobile

Article	Code	Kg
SP - F	201526	0,920



Movable Support for dial gauge on guide Portacomparatore su guida lineare

Article	Code	Kg
SP - M	201525	1,100

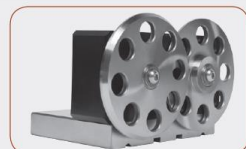

Article	Code	Kg
TR-R	201510	6,580

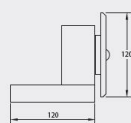

Article	Code	Kg
TR RM	201511	7,180

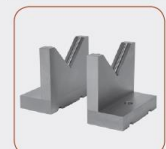
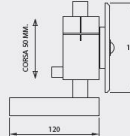

Article	Code	Kg
SV	201520	0,600

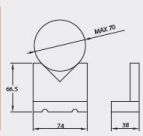

"V" SUPPORTS SUPPORTI A "V"