

**APPLICAZIONI** APPLICATIONS

Applicazione per interni Inside application

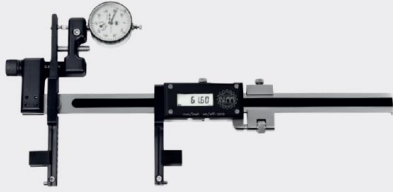

Applicazione per esterni Outside application

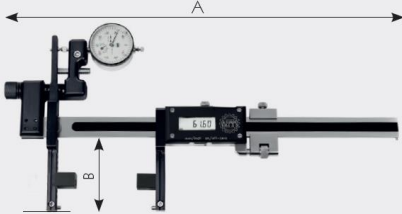

Esempio di applicazione Example of application



## APPLICATIONS APPLICAZIONI

For interchangeable ends  
see pag. 106 - 107

Per i Terminali intercambiabili  
vedere a pag. 106 - 107

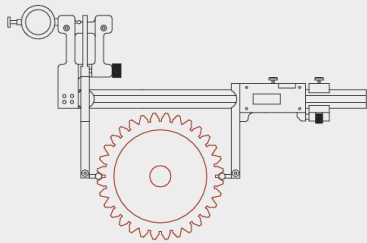
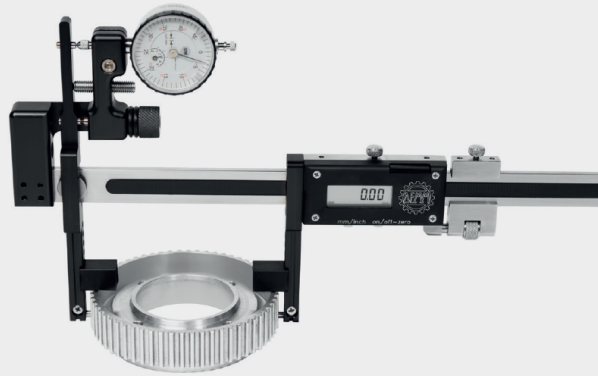

OUTSIDE TOOTH MEASUREMENT  
CONTROLLO DENTATURE ESTERNE

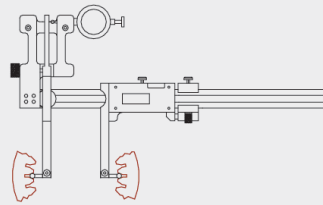

INSIDE TOOTH MEASUREMENT  
CONTROLLO DENTATURE INTERNE

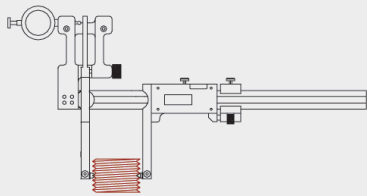

OUTSIDE THREAD MEASUREMENT  
CONTROLLO FILETTATURE ESTERNE

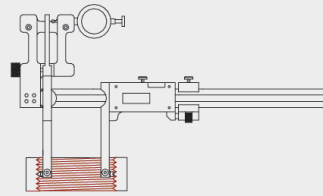

INSIDE THREAD MEASUREMENT  
CONTROLLO FILETTATURE INTERNE

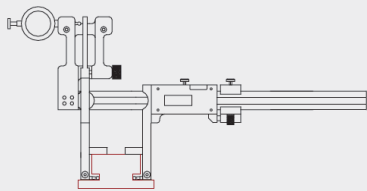

OUTSIDE CHANNEL AND GROOVE MEASUREMENT  
CONTROLLO CANALINI E GOLE ESTERNE

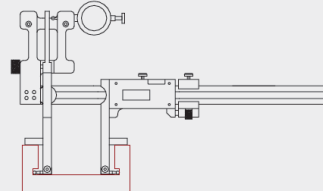

INSIDE CHANNEL AND GROOVE MEASUREMENT  
CONTROLLO CANALINI E GOLE INTERNE

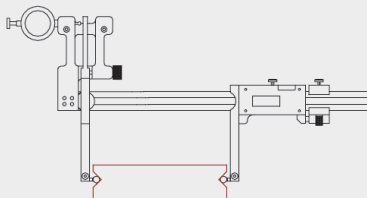

OUTSIDE "V" GUIDE MEASUREMENT  
CONTROLLO GUIDE A "V" ESTERNE

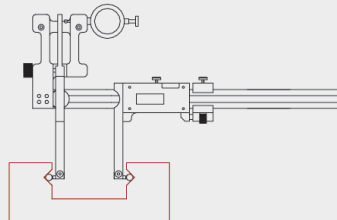

INSIDE "V" GUIDE MEASUREMENT  
CONTROLLO GUIDE A "V" INTERNE